

Contadores Magnéticos SD-2 Línea Challenger®

SD2150AM, Contadores Magnéticos 3P - Normas IEC 60947-2



STECK

El contactor de la Serie SD-2 es usado en circuitos AC 50/60Hz, tensión nominal de trabajo hasta 690V e intensidad nominal de trabajo hasta 630A de acuerdo con la clase de empleo AC-3. Es usado para poder conectar y desconectar un circuito a distancia. Conectado a un relé térmico protege el circuito contra sobre carga y conmutador estrella – triangulo cuando combina con bloques auxiliares. Este producto está en conformidad con las normas IEC 60947-1 e GB 14048.4.

Especificaciones Técnicas

Ie (A) AC-3 380/400V	150A	
Ith (A) Corriente térmica convencional (AC-1)	200A	
Número de polos	3	
Tensión Nominal Ue (Vca)	690Vac	
Tensión Nominal de Aislamiento Ui (Vca)	690Vac	
Potencia Nominal Clase AC-3 (kW)	220/240V	40
	380/400V	75
	415/440V	80
	660/690V	100
Frecuencia de operación (Ciclos/hora) AC-3	600	

Especificaciones Técnicas

Vida Útil N° de maniobras

N° de maniobras Eléctricas (x 10⁴ ciclos)

120

N° de maniobras Mecánicas (x 10⁴ ciclos)

1000

Bobina

Límite de tensión de funcionamiento de bobina

85% - 110% Us

Tensión de Bobina (VAC)

230

Contacto Auxiliar

Corriente Térmica Convencional (A)

10A

Tensión (Ue)

AC (V)

400

DC (V)

230

Capacidad de Control

AC-15 (VA)

360

DC-15 (W)

33

Secciones

Sección del Cable (mm²) 1un

120 mm²

Sección de Cable (mm²) 2un

-

Barraje de Cable (mm²) 2un

25 X 3

BOBINAS PARA SD2

CÓDIGOS PARA REPOSICIÓN

CODIGOS DE BOBINA

Contadores >	SD2115A/ SD2150A	SD2185A/ SD2225A	SD2265A/ SD2330A	SD2400A	SD2500A	SD2630A
110V	SB150F	SB225F	SB330F	SB400F	SB500F	SB630F
127V	SB150G	SB225G	SB330G	SB400G	SB500G	SB630G
220V	SB150M	SB225M	SB330M	SB400M	SB500M	SB630M
380V	SB150Q	SB225Q	SB330Q	SB400Q	SB500Q	SB630Q
440V	SB150R	SB225R	SB330R	SB400R	SB500R	SB630R

Dimensiones

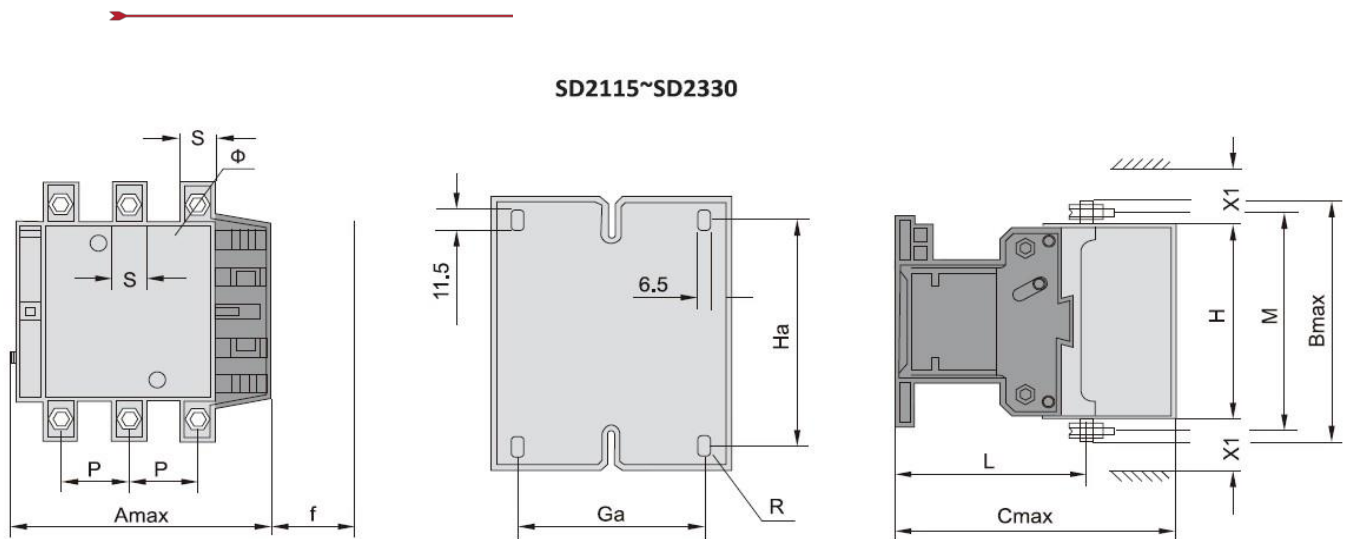

Frame SD2115 a SD2330

Referencia	A max	B max	C max	P	S	Ø	f	M	H	L	X1	X1	Ga	Ha
											(200~550V)	(600~100V)		
SD2115A	167	163	172	37	20	M6	131	147	124	107	10	15	80	110~120
SD2150A	167	171	172	40	20	M8	131	150	124	107	10	15	80	110~120
SD2115A	171	174	183	40	20	M8	131	154	127	113.5	10	15	80	110~120
SD2150A	171	197	183	48	25	M10	131	172	127	113.5	10	15	80	110~120
SD2115A	202	203	215	48	25	M10	147	178	147	141	10	15	96	110~120
SD2150A	213	206	220	48	25	M10	147	181	158	145	10	15	96	110~120

Nota: f - Espacio reservado para mover la bobina

Esquema De Encendido



SD2115~SD2630

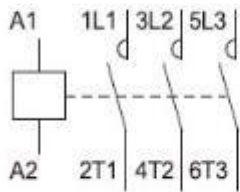

SD2115~SD2630

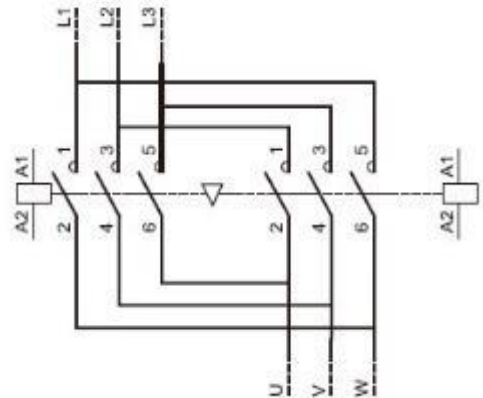

Contacto Auxiliar



Posición	Número de polos	Contactos		Referencia
		NA	NF	
Frontal	2	0	2	SF02
		1	1	SF11
		2	0	SF20
	4	0	4	SF04
		1	3	SF13
		2	2	SF22
		3	1	SF31
		4	0	SF40
Lateral	2	0	2	SL02
		1	1	SL11
		2	0	SL20

Bloque de contacto temporizado

Posiciones/Contactos	Tipo	Rango de ajuste	Referencia
Frontal/NA+NF	Al trabajo	0,1~3s	ST20
		0,1~30s	ST22
		10~180s	ST24
	Al reposo	0,1~3s	ST30
		0,1~30s	ST32
		10~180s	ST34

Juego de Contactos	
Corriente contactor	Referencia
115A	SJ115D
150A	SJ150D
185A	SJ185D
225A	SJ225D
265A	SJ265D
330A	SJ330D
400A	SJ400D
500A	SJ500D
630A	SJ630D

Interbloqueo Mecánico	
Corriente contactor	Referencia
115A	SMIF
150A	
185A	SMIG
225A	
265A	SMIH
330A	
400A	SMIK
500A	
630A	SMIL

Accesorios

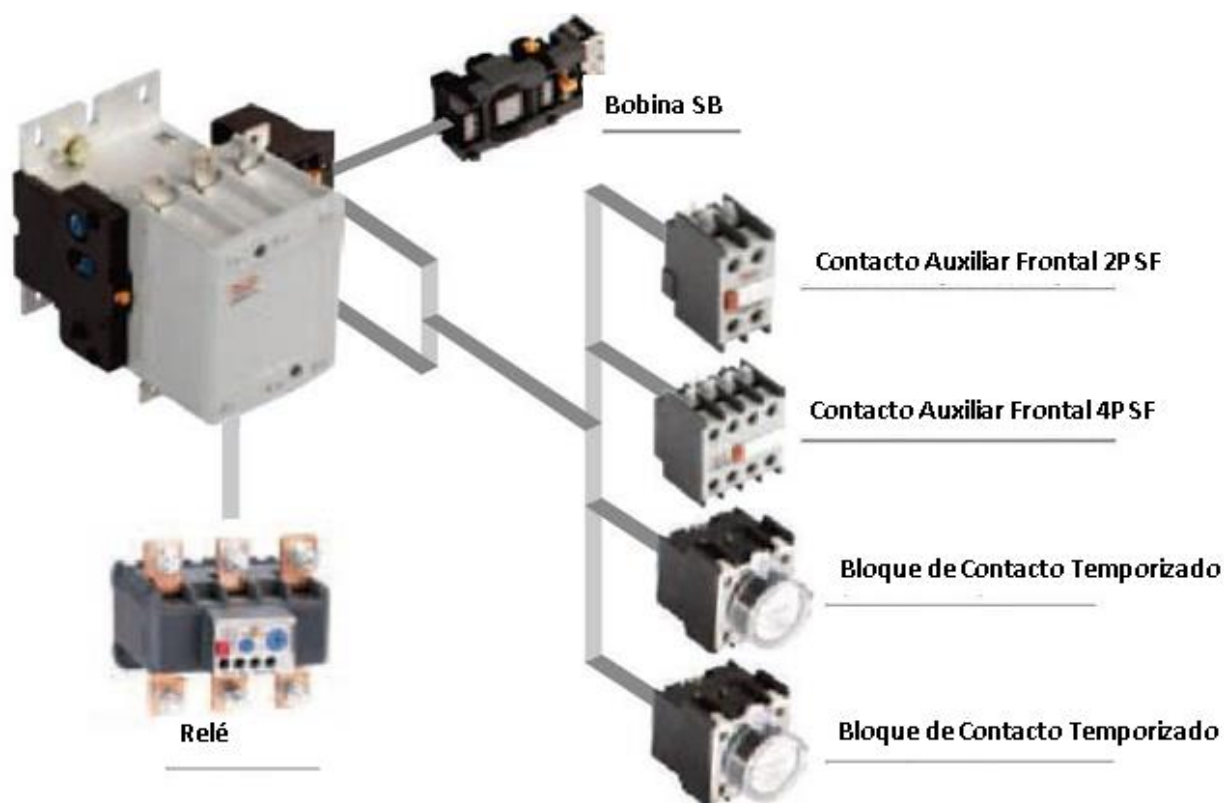



STECK

