

CR Series

Cylindrical, Capacitive type proximity sensor

■ Features

- Sensing of iron, metal, plastic, water, stone, wood etc.
- Long life cycle and high reliability
- DC type: Built-in surge protection circuit, reverse polarity protection circuit
AC type: Built-in surge protection circuit
- Easy to adjust of the sensing distance with sensitivity adjuster
- Red LED operation indicator
- Easy to control of level and position



⚠ Please read "Safety Considerations" in the instruction manual before using.

■ Type

◎ DC 3-wire type

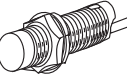
Appearances	Model
 M18	CR18-8DN
	CR18-8DP
	CR18-8DN2 ※
 M30	CR30-15DN
	CR30-15DP
	CR30-15DM2 ※

※ mark can be customized.

◎ AC 2-wire type

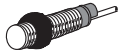
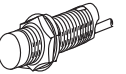
Appearances	Model
 M18	CR18-8AO
	CR18-8AC
 M30	CR30-15AO
	CR30-15AC

■ Specifications

Model	CR18-8DN CR18-8DP CR18-8DN2	CR30-15DN CR30-15DP CR30-15DN2	CR18-8AO CR18-8AC	CR30-15AO CR30-15AC
Diameter of the sensing side	18mm	30mm	18mm	30mm
Sensing distance	8mm	15mm	8mm	15mm
Installation	Non-shield (non-flush)			
Hysteresis	Max. 20% of sensing distance			
Standard sensing target	50×50×1mm (iron)			
Setting distance	0 to 5.6mm	0 to 10.5mm	0 to 5.6mm	0 to 10.5mm
Power supply (operating voltage)	12-24VDC= (10-30VDC=)		100-240VAC~ 50/60Hz (85-264VAC~)	
Current consumption	Max. 15mA		—	
Leakage current	—		Max. 2.2mA	
Response frequency*1	50Hz		20Hz	
Residual voltage	Max. 1.5V		Max. 20V	
Affection by Temp.	Max. ±20% for sensing distance at ambient temperature 20°C			
Control output	Max. 200mA		5 to 200mA	
Insulation resistance	Over 50MΩ (at 500VDC megger)			
Dielectric strength	1,500VAC 50/60Hz for 1 min			
Vibration	1mm amplitude at frequency of 10 to 55Hz (for 1 min) in each of X, Y, Z direction for 2 hours			
Shock	500m/s ² (approx. 50G) in each of X, Y, Z direction for 3 times			
Indicator	Operation indicator: Red LED			
Environment	Ambient temperature -25 to 70°C, storage: -30 to 80°C Ambient humidity 35 to 95%RH, storage: 35 to 95%RH			
Protection circuit	Reverse polarity protection circuit, Surge protection circuit		Surge protection circuit	
Protection structure	IP66 (IEC standard)	IP65 (IEC standard)	IP66 (IEC standard)	IP65 (IEC standard)
Cable	Ø4mm, 3-wire, 2m	Ø5mm, 3-wire, 2m	Ø4mm, 2-wire, 2m	Ø5mm, 2-wire, 2m
Material	CR18 - Case/Nut: PA6, Standard cable (black): Polyvinyl chloride (PVC) CR30 - Case/Nut: Nickel plated brass, Washer: Nickel plated iron, Sensing surface: Polybutylene terephthalate, Standard cable (black): Polyvinyl chloride (PVC)			
Weight*2	Approx. 88g (approx. 76g)	Approx. 243g (approx. 206g)	Approx. 82g (approx. 70g)	Approx. 237g (approx. 200g)

*1: The response frequency is the average value. The standard sensing target is used and the width is set as 2 times of the standard sensing target, 1/2 of the sensing distance for the distance.

*2: The weight includes packaging. The weight in parenthesis is for unit only.

※Environment resistance is rated at no freezing or condensation.

Cylindrical, Capacitive type

■ Dimensions

(unit: mm)

● CR18-8 □ □

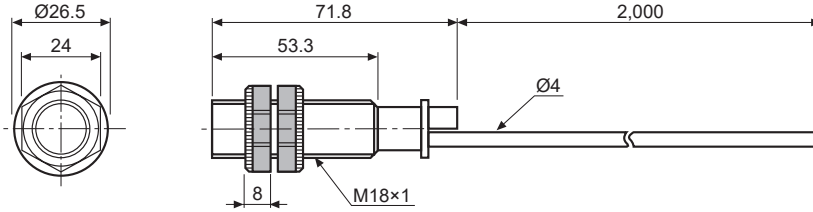

● CR30-15 □ □

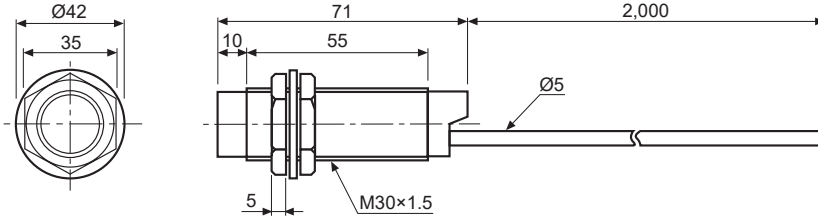

■ Control Output Diagram and Load Operation

■ Connections

◎ DC 3-wire type

◎ DC 3-wire type

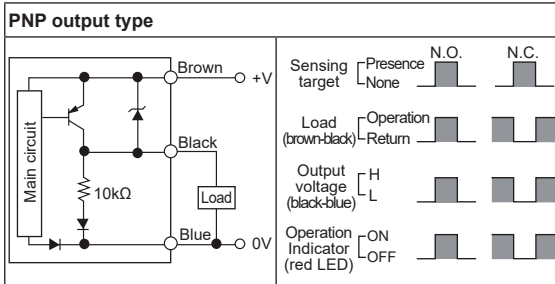
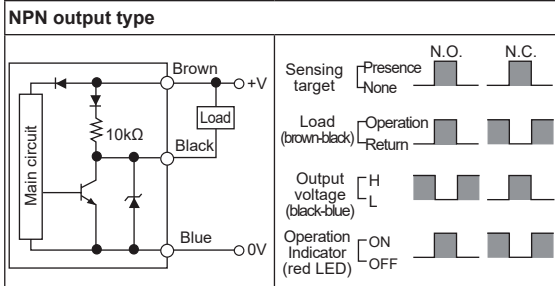

◎ AC 2-wire type

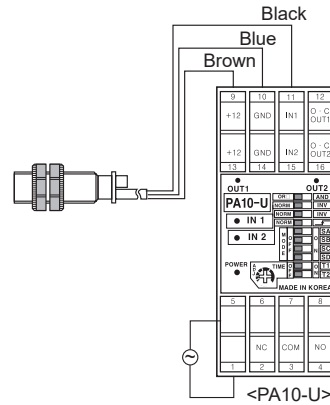
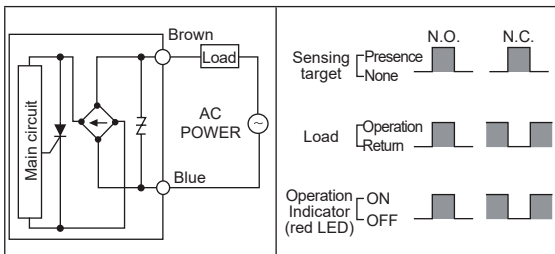

◎ AC 2-wire type

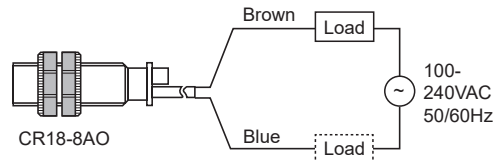

SENSORS

CONTROLLERS

MOTION DEVICES

SOFTWARE

(A) Photoelectric Sensors

(B) Fiber Optic Sensors

(C) LIDAR

(D) Door/Area Sensors

(E) Vision Sensors

(F) Proximity Sensors

(G) Pressure Sensors

(H) Rotary Encoders

(I) Connectors/ Connector Cables/ Sensor Distribution Boxes/ Sockets

CR Series

■ Sensitivity Adjustment

Please turn potention VR to set sensitivity as below procedure.

1. Without a sensing object, turn the potention VR to the right and stop at the proximity sensor is ON (OFF).



2. Put the object in right sensing position, turn the potention VR to the left and stop at the proximity sensor is OFF (ON).



3. If the difference of the number of potention VR rotation between the ON (OFF) point and the OFF (ON) point is more than 1.5 turns, the sensing operation will be stable.

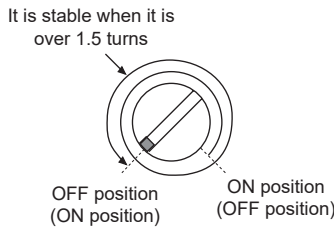

4. If it is set in sensitivity adjustment position of potention VR at center between 1 and 2, sensitivity setting will be completed.

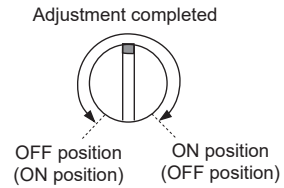

※When there is distance fluctuation between proximity sensor and the target, please adjust 2 at the farthest distance from this unit.

※Turning potention VR toward clockwise, it will be max., or turning toward counter clockwise, it will be min. The number of adjustment should be 15 ± 3 revolution and if it is turned to the right or left excessively, it will not stop, but it idles without breakdown.

※() is for Normally closed type.

■ Grounding

The sensing distance will be changed by grounding status of capacitive proximity sensor and the target[50×50×1mm(Iron)]. Please check the material when installing the sensor and selecting the target.

● CR18 type

Ground condition (switch b)	ON	OFF
Operating distance (mm)	8	4

● CR30 type

Ground condition	Switch a	ON	OFF	ON	OFF
	Switch b	ON	ON	OFF	OFF
Operating distance (mm)		15	18	6	6

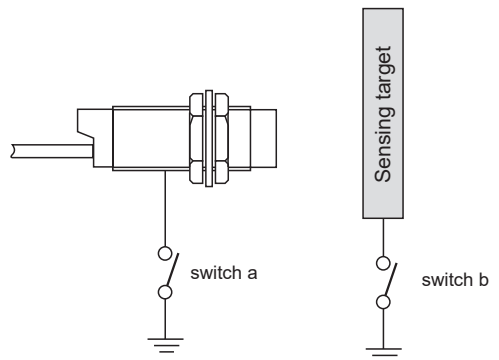
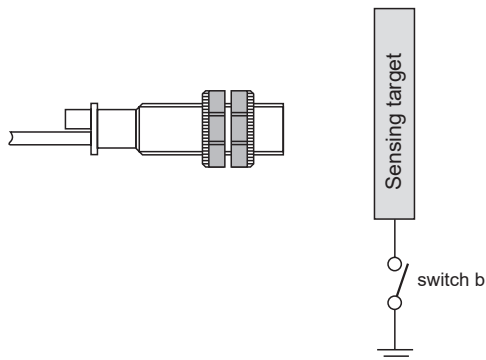

Cylindrical, Capacitive type

■ Mutual-Interference & Influence by Surrounding Metals

When several proximity sensors are mounted closely, malfunction of sensor may be caused due to mutual interference. Therefore, be sure to keep a minimum distance between the two sensors as below charts.

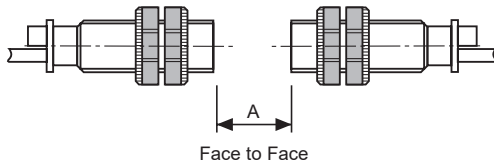

(unit: mm)

Item \ Model	CR18	CR30
A	48	90
B	54	90

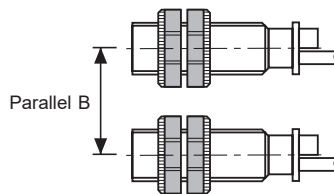

When sensors are mounted on metallic panel, you must prevent the sensors from malfunction by any metallic object. Therefore, be sure to keep a minimum distance as below charts.

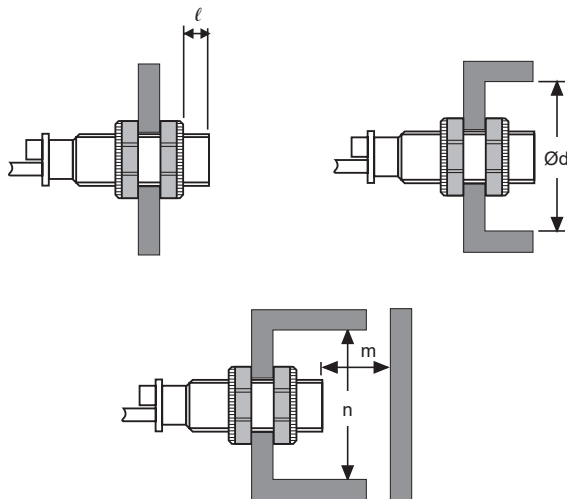

(unit: mm)

Item \ Model	CR18	CR30
l	20	10
$\varnothing d$	54	90
m	24	45
n	54	90

■ Materials

◎ Materials of sensing targets

Sensing distance may be different by electrical characteristic of sensing target (conductivity, non dielectric constant) and status of water absorption, size etc.

◎ Effect by high frequency electrical field

It may cause malfunction by machinery which generate high frequency of electrical field such as a washing machine etc.

◎ Surrounding environment

There is water or oil on surface of sensing part, it may cause malfunction.

If the bottle for sensing of level is coated by oil etc., it may cause malfunction.

Especially, 15mm type has high sensitivity for induced objects, please be careful of waterdrops.

◎ Organic solvents

Do not let the oil or oil liquid is flowed into the sensor because the case is made by plastic.

SENSORS

CONTROLLERS

MOTION DEVICES

SOFTWARE

(A) Photoelectric Sensors

(B) Fiber Optic Sensors

(C) LIDAR

(D) Door/Area Sensors

(E) Vision Sensors

(F) Proximity Sensors

(G) Pressure Sensors

(H) Rotary Encoders

(I) Connectors/ Connector Cables/ Sensor Distribution Boxes/ Sockets